

NEED HELP?

DO NOT RETURN TO STORE. PLEASE VISIT US AT:
www.polygroupstore.com OR 1-888-919-0070

TREE ASSEMBLY INSTRUCTIONS

Congratulations on purchasing your new tree from **Polygroup®**! This tree comes with Quick Set® technology-Set up and light up your tree in less than 10 minutes! Carefully follow the instructions below on how to quickly and easily set up your new tree.

1. Before you start to assemble your tree, choose an appropriate location near a wall outlet.
2. Assemble the tree stand and place on a level surface. (See Fig. A)

Fig. A - Tree Stand Assembly

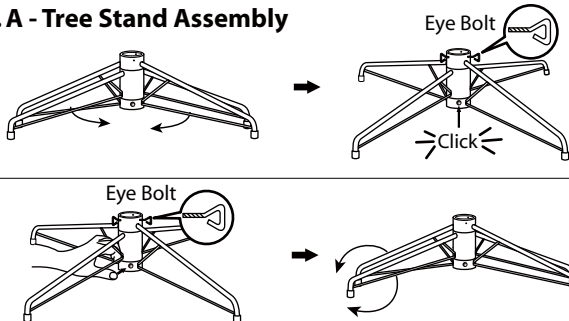

1. Pull apart the legs of the stand so that they are snapped into an x-shape, place the tree stand on a level surface.
2. When inserting the bottom section of the tree into the assembled stand, insert and turn the eyebolts into the stand and tighten until the tree pole is firmly secured.

To close the stand, remove the eyebolts, press the metal button and fold the legs together.

Fig. B - Tree and Light Assembly

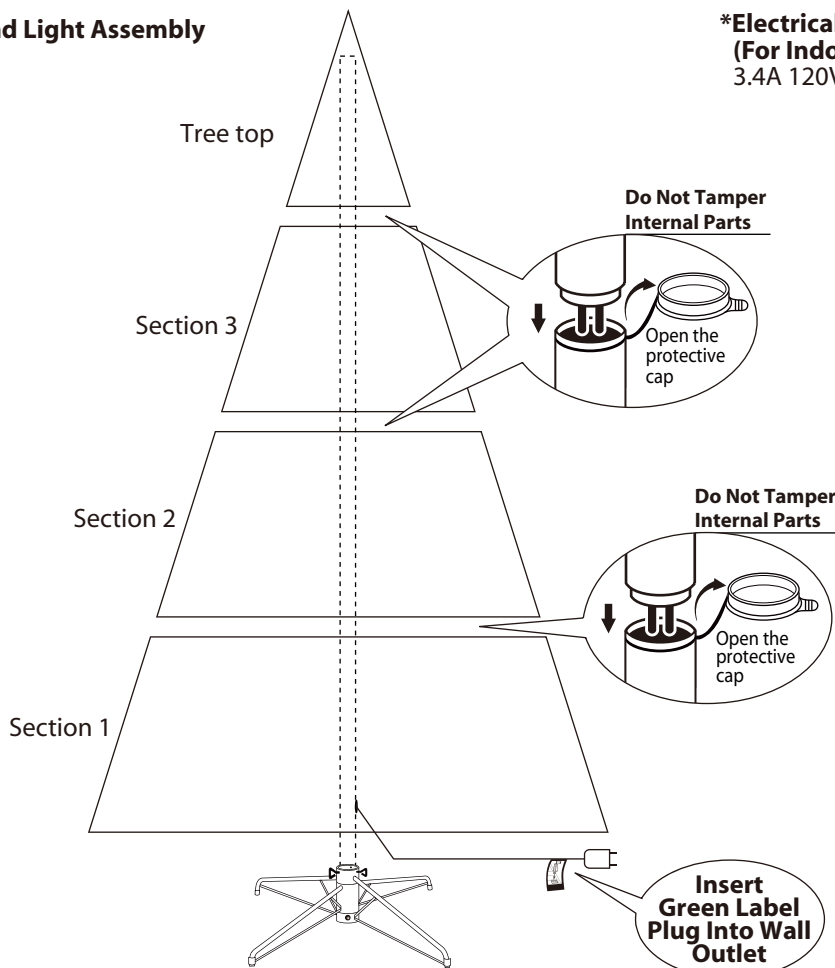

***Electrical Rating For The Tree
(For Indoor Use Only)
3.4A 120V 60Hz**

3. Each tree section is numbered with a sticker. Please identify all sections before assembling.
4. Assemble the tree from the bottom to the top. Start with the bottom section and remove protective cap before inserting into the assembled stand. Make sure the pole is firmly inserted and secured into the stand.
5. Continue by inserting the upper tree section(s) to the lower section(s) until inserting the tree top.
6. Allow branches to fall into place or gently pull up and out. When adjusting branches, be sure that all wires are free of branch hinges.
7. Insert green label plug into the wall outlet. (see Fig. B), your entire tree should now be lit. If some bulbs do not light or flickers, search for any loose plugs and/or broken, loose or missing bulbs. Connecting the plugs or replace bulbs promptly in order to maintain the performance and life expectancy of your pre-lit tree.

8. Begin to shape the branches and tips working from the bottom to the top. Start with tips farthest from the pole and fan out one to the right, one to the left and one at the center of the main stem. **(See Fig. C)**



9. After shaping the entire tree following the previous step, slightly upsweep all branch tips for a uniform look. Shift branches to fill any gaps. Your Christmas tree is now complete and ready to be decorated.

STORAGE INSTRUCTIONS

1. Unplug extension cord from the wall outlet first and then remove all ornaments and decorations.
2. Disassemble the tree from the top to the bottom. Start with the tree top and gently lift straight up to remove from section below and fold all branches toward the pole.
3. Continue by gently lifting straight up each section(s) from the section below and fold all branches toward the pole until the bottom section is removed from the tree stand. Cover the protective cap on the poles to avoid damaging the internal parts. **(See Fig. D)**
4. Carefully place all tree sections into shipping box and tape it shut.
5. When not in use, please store your tree in a cool, dry place away from sunlight. Exposing your tree to excessive heat or humidity may damage your tree.
6. Keep out of reach of pets and children.



TROUBLESHOOTING TIPS

For Pre-lit Trees, If The Tree Does Not Illuminate

1. Please check to make sure that all plugs are properly connected and power cord is plugged into the wall outlet.
2. Turning the poles gently to make sure pole to pole are connected into place.
3. Check for loose connection between light string plugs and extension cords.
4. Please check for loose, broken or missing light bulbs and replace as needed.

Loose Hinge Pin

1. Extra hinge pins are included for repairing the hinges. Place the branch into the slot of the bracket.
2. Insert a new hinge pin through the hole and secure using the retainer washer. **(See Fig. E)**

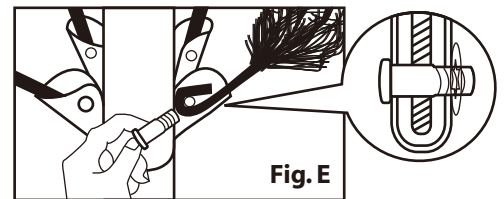

SPARE PARTS

Each tree includes hinge pins/washers, and for pre-lit trees spare bulbs and fuses are also included. If extra parts are needed, please contact our customer service center.

CUSTOMER SERVICE FOR CHRISTMAS TREES

For any questions, assistance, or missing parts, **Do Not Return To Place Of Purchase.** Please contact us at 1-888-919-0070 or visit our website at www.polygroupstore.com. One of our customer service representatives will be happy to assist you.

Tree ID#: _____

Customer Name: _____

Tree UPC#: _____

Address:(No P.O. Boxes) _____

Store Purchased: _____

City & State: _____

Specify Problem: _____

Zip Code: _____

Day Phone: _____

Date Purchased: _____

TREE ID# IS LOCATED ON END PANEL OF BOX. TREE ID# IS REQUIRED WHEN REQUESTING REPLACEMENT PARTS.