

NEED HELP?

DO NOT RETURN TO STORE. PLEASE VISIT US AT:
www.polygroupstore.com OR 1-888-919-0070

3.6 m / 12 ft EZ Connect™ Pre-lit Aspen Radiant Micro LED™ Tree ITM. / ART. 2002053, 279940, 8519178 IMPORTANT, RETAIN FOR FUTURE REFERENCE: READ CAREFULLY

For assistance with assembly, parts and customer service, call (US & Canada only): **1-888-919-0070** (English, Spanish, French) at 10am-6pm, Mon-Fri, Eastern Time, email: warranty@polygroup.com, or visit www.polygroupstore.com.

Please note if you are calling outside of USA & Canada, international toll fees may apply.
Customer Service Hotline Hours: 8am-4pm, Mon-Fri, MST.

TREE ASSEMBLY INSTRUCTIONS

This tree comes with EZ Connect™ and Simple Shape™ technology, allowing you to set up and light your tree in less than 10 minutes! Carefully follow the instructions below on how to quickly and easily set up your new tree.

1. Choose an appropriate location near a wall outlet.
2. Assemble the tree stand on a level surface. (See Fig. A)

Fig. A - Tree Stand Assembly

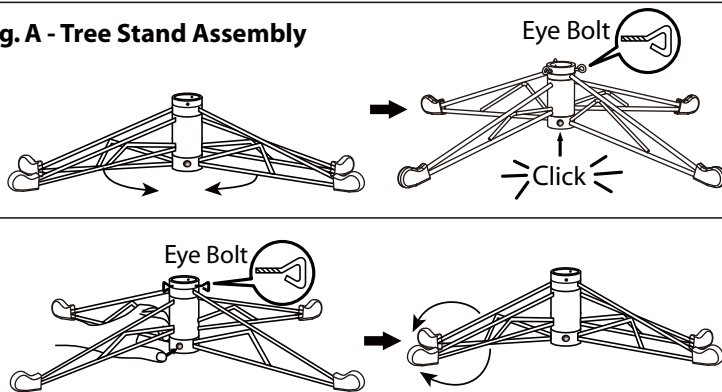

1. Pull apart tree stand legs until they snap and form an 'X' shape.
2. Insert the tree bottom into the assembled stand. Insert and tighten the eye bolt into the stand until firmly secured.
3. To close the stand, press the metal button and fold the legs together.

Fig. B - Tree and Light Assembly

(For Indoor Use Only)

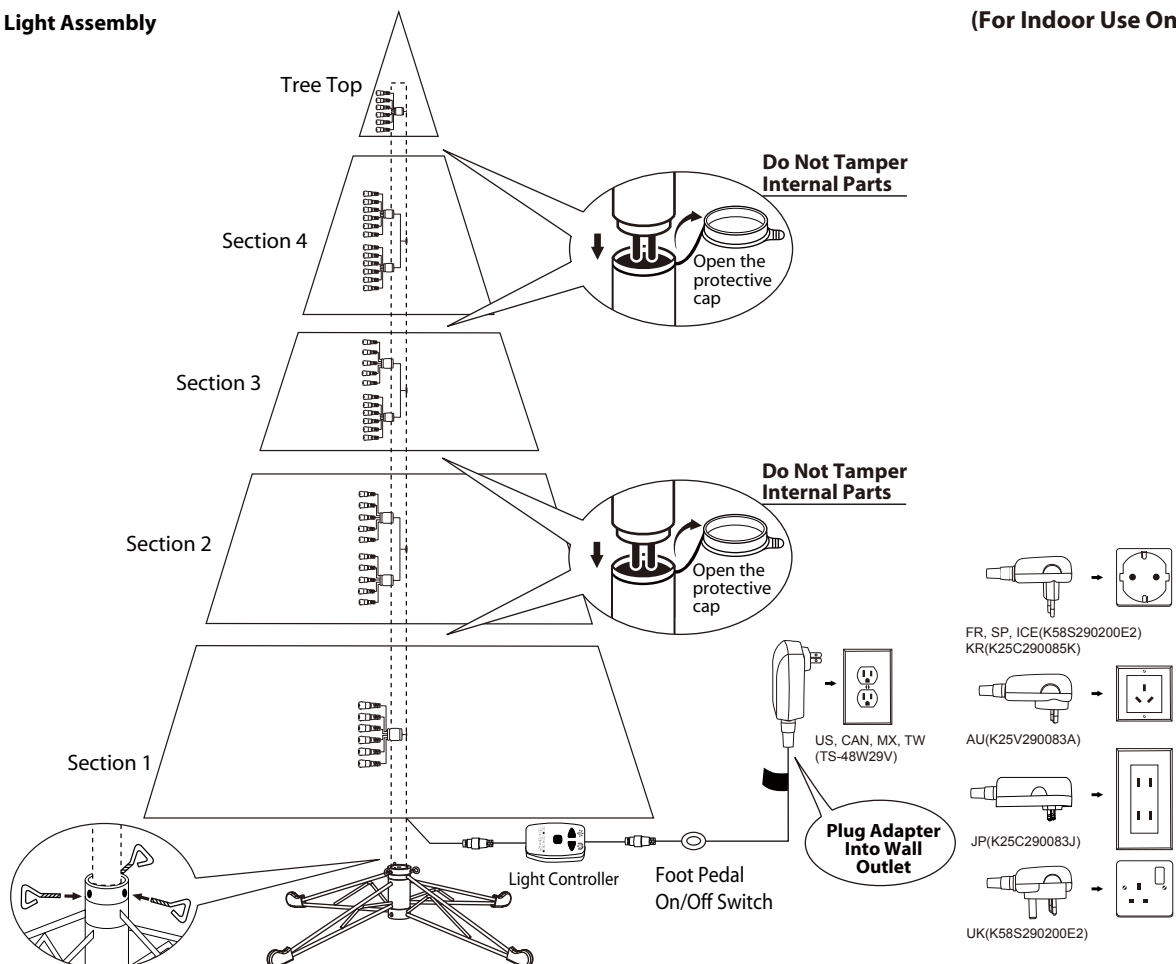

- Each tree section is numbered with a sticker. Please identify all sections before assembling.
- Assemble the tree from the bottom to the top (**See Fig. B**). Remove protection cap, and insert the center pole into the stand. Then slot together the remaining poles securely until the tree top is installed. Be sure that all cords are free from branch hinges.
- Plug the adapter into the wall outlet (**See Fig. B**). Your entire tree should now be lit.
- This is a Simple Shape™ tree and no shaping is required. Just slightly upsweep all tips (**See Fig. C**) and shift branches to fill in any gaps for a fuller, uniform look. Your Christmas tree is now ready to be decorated.

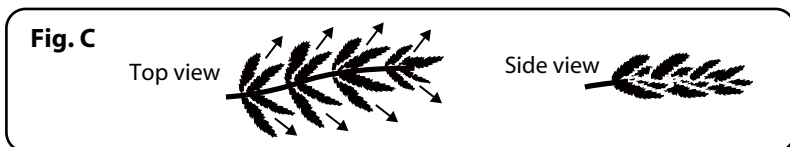

STORAGE INSTRUCTIONS

- Unplug adapter from the wall outlet. Then remove all ornaments and decorations.
- Disassemble the tree from the top to the bottom. Gently lift the center pole straight up to remove from the section below, and fold all branches toward the pole. Continue until the lowest tree section is removed from the tree stand.
- Close the protective caps on the poles to avoid damaging the internal parts. (**See Fig. D**)
- Carefully place all tree sections into the shipping box and tape (not included) it shut.
- Store your tree in a cool, dry place away from sunlight. Exposure to excessive heat or humidity may damage your tree.
- Keep out of reach of pets and children.



TROUBLESHOOTING TIPS

If Tree Does Not Illuminate / Some Bulbs Do Not Light or Flicker

- Check to make sure that all connectors are properly connected and the adapter is plugged firmly into the wall outlet.
- Turn the poles gently to ensure pole-to-pole connection is secured.
- Try stepping on the On/Off switch foot pedal.

Loose Hinge Pin

- Place the branch into the slot of the bracket.
- Insert a new hinge pin (included) through the hole and secure with a retainer washer (included). (**See Fig. E**)

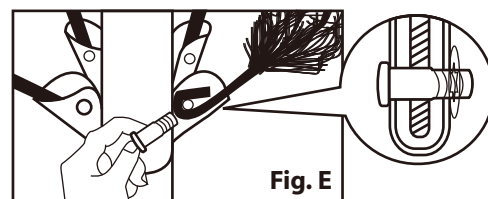

SPARE PARTS

This tree includes hinge pins/washers. If extra parts are needed, please contact our customer service center.

REMOTE CONTROL INSTRUCTIONS

- Remove the insulation tab of the remote control.
- Press either selector button and wait for a second to enjoy light effects in the following sequence (see **DUAL COLOR LIGHT CONTROLLER & REMOTE CONTROL**).

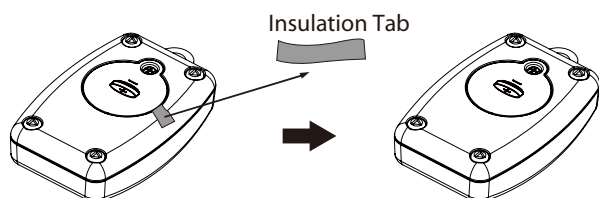

DUAL COLOR LIGHT CONTROLLER INSTRUCTIONS

Simply press the selector button to select from the following light functions: **1. CLEAR STEADY 2. CLEAR FADING 3. MULTI-COLOR STEADY 4. MULTI-COLOR FADING 5. CLEAR/MULTI-COLOR ALTERNATING**

There are 13 brightness levels. Simply press the controller buttons to increase  or decrease  the brightness to your liking.

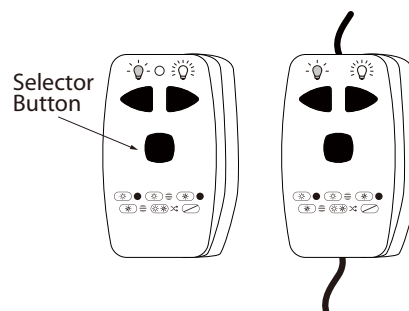

BATTERY REPLACEMENT

1. Loosen the screw of the battery cover with a screwdriver (not included).

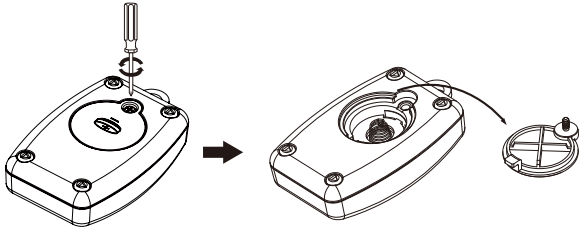

2. Replace the used battery with a new CR2032 button cell battery (not included). Make sure that the battery is installed with the correct polarity (+ and -).

3. Retighten the screw to close and secure the battery cover.

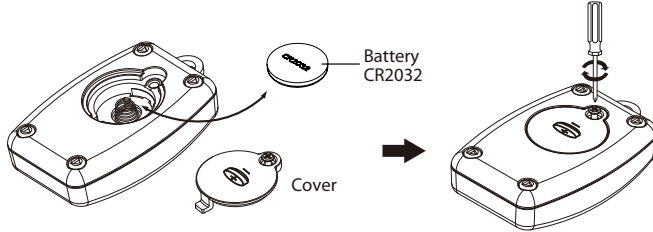

WARNING

1. Use only the power adapter supplied with this product. Using a different adapter can damage the lights and will cause fire or electrical shock hazards.
2. For indoor use only.
3. This product contains a CR2032 button cell battery. If swallowed, it could cause severe injury or death in just 2 hours due to chemical burns and potential perforation of the oesophagus – seek medical attention immediately.



4. Keep batteries out of reach of children.
5. If you suspect your child has swallowed or inserted a button cell battery, immediately seek urgent medical assistance.
6. Make sure the battery compartment is correctly secured (e.g. the screw or other mechanical fastener is tightened), and do not use if the compartment is not secured.
7. Dispose of used button cell batteries immediately and safely. Flat batteries can still be dangerous.
8. Inform others about the risk associated with button cell batteries and how to keep their children safe.
9. Do not expose the lights to moisture.
10. Remove the batteries when the controllers are left unused, and are not expected to be used for an extended period of time, or when depleted.
11. Dispose of the used battery properly as per the directions on batteries, and local laws and regulations regarding the disposal of hazardous waste.
12. Clean the battery contact surfaces prior to battery installation.
13. Do not dispose of batteries in fire – batteries may leak or rupture.

DISPOSAL OF USED BATTERIES



Battery may contain hazardous substances which could endanger the environment and human health.

This symbol marked on the battery and/ or packaging indicates that used battery shall not be treated as municipal waste. Batteries should be disposed of at an appropriate collection point for recycling. By ensuring the used batteries are disposed of correctly, you will help preventing potential negative consequences for the environment and human health. The recycling of materials will help to conserve natural resources. For more information about recycling of used batteries, please contact your local municipality waste disposal service.

Hereby, Polygroup declares that the Christmas Tree is in compliance with RED 2014/53/EU.

AUSTRALIA: Our goods come with guarantees that cannot be excluded under the Australian Consumer Law. You are entitled to a replacement or refund for a major failure and for compensation for any other reasonably foreseeable loss or damage. You are also entitled to have the goods repaired or replaced if the goods fail to be of acceptable quality and the failure does not amount to a major failure.

Distributed by:
Costco Wholesale Corporation
P.O. Box 34535
Seattle, WA 98124-1535
USA
1-800-774-2678
www.costco.com

Costco Wholesale Iceland ehf.
Kauptún 3-7, 210 Gardabaer
Iceland
www.costco.is

Imported by / Importé par :
Costco Wholesale Canada Ltd.*
415 W. Hunt Club Road
Ottawa, Ontario
K2E 1C5, Canada
1-800-463-3783
www.costco.ca
* faisant affaire au Québec sous
le nom Les Entrepôts Costco

Costco France
1 avenue de Bréhat
91140 Villebon-sur-Yvette
France
01 80 45 01 10
www.costco.fr

Importadora Primex S.A. de C.V.
Blvd. Magnocentro No. 4
San Fernando La Herradura
Huixquilucan, Estado de México
C.P. 52765
RFC: IPR-930907-S70
(55)-5246-5500
www.costco.com.mx

Costco Wholesale Japan Ltd.
3-1-4 Ikegami-Shincho
Kawasaki-ku, Kawasaki-shi,
Kanagawa 210-0832 Japan
044-281-2600
www.costco.co.jp

Costco Wholesale Australia Pty Ltd
17-21 Parramatta Road
Lidcombe NSW 2141
Australia
www.costco.com.au

Costco Wholesale Korea, Ltd.
40, Iljik-ro
Gwangmyeong-si
Gyeonggi-do, 14347, Korea
1899-9900
www.costco.co.kr

Costco Wholesale UK Ltd /
Costco Online UK Ltd
Hartspring Lane
Watford, Herts
WD25 8JS
United Kingdom
01923 213113
www.costco.co.uk

Costco President Taiwan, Inc.
No. 656 Chung-Hwa 5th Road
Kaohsiung, Taiwan
Company Tax ID: 96972798
449-9909 or 02-449-9909 (if cellphone)
www.costco.com.tw

Shanghai Minhang Costco Trading Co., Ltd
Unit 109, No. 388, Lian You Road,
Minhang District, Shanghai
China 201107
+86-21-6257-7065

Costco Wholesale Spain S.L.U.
Polígono Empresarial Los
Gavilanes
C/ Agustín de Betancourt, 17
28906 Getafe (Madrid) España
NIF: B86509460
900 111 155
www.costco.es

MADE IN CHINA / FABRIQUÉ EN CHINE / HECHO EN CHINA

CUSTOMER SERVICE FOR CHRISTMAS TREES

For any questions, assistance, or missing parts, **DO NOT RETURN YOUR TREE TO PLACE OF PURCHASE.** Please contact us via: call (US & Canada only) 1-888-919-0070 (English, Spanish, French) at 10am-6pm, Mon-Fri, Eastern Time, email: warranty@polygroup.com, or visit www.polygroupstore.com.

Tree ID#: _____

Customer Name: _____

Tree UPC#: _____

Address (No P.O. boxes): _____

Store Purchased: _____

City & State: _____

Specify Problem: _____

Zip Code: _____

Day Phone: _____

Date Purchased: _____

TREE ID# IS LOCATED ON END PANEL OF BOX. TREE ID# IS REQUIRED WHEN REQUESTING REPLACEMENT PARTS.