

model no. 151-5592-0 | Toll-free number: 1-866-827-4985

IMPORTANT: Please read this manual carefully before assembly and save it for reference.

TREE ASSEMBLY INSTRUCTIONS

Carefully follow the instructions below to quickly and easily set up your new tree.

Set up and light up your tree in less than 10 minutes. Carefully follow the instructions below on how to quickly and easily set up your new tree.

1. Before you start to assemble your tree, choose an appropriate location near a wall outlet.
2. Assemble the tree stand and place on a level surface. (See Fig. A.)

Fig. A - Tree Stand Assembly

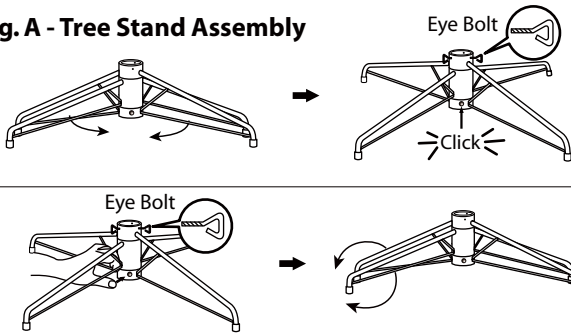

1. Pull apart the legs of the stand so that they are snapped into an X-shape, and place the tree stand on a level surface.
2. When inserting the bottom section of the tree into the assembled stand, insert and turn the eye bolts into the stand and tighten until the tree pole is firmly secured.

To close the stand, remove the eye bolts, press the metal button and fold the legs together.

Fig. B - Tree and Light Assembly

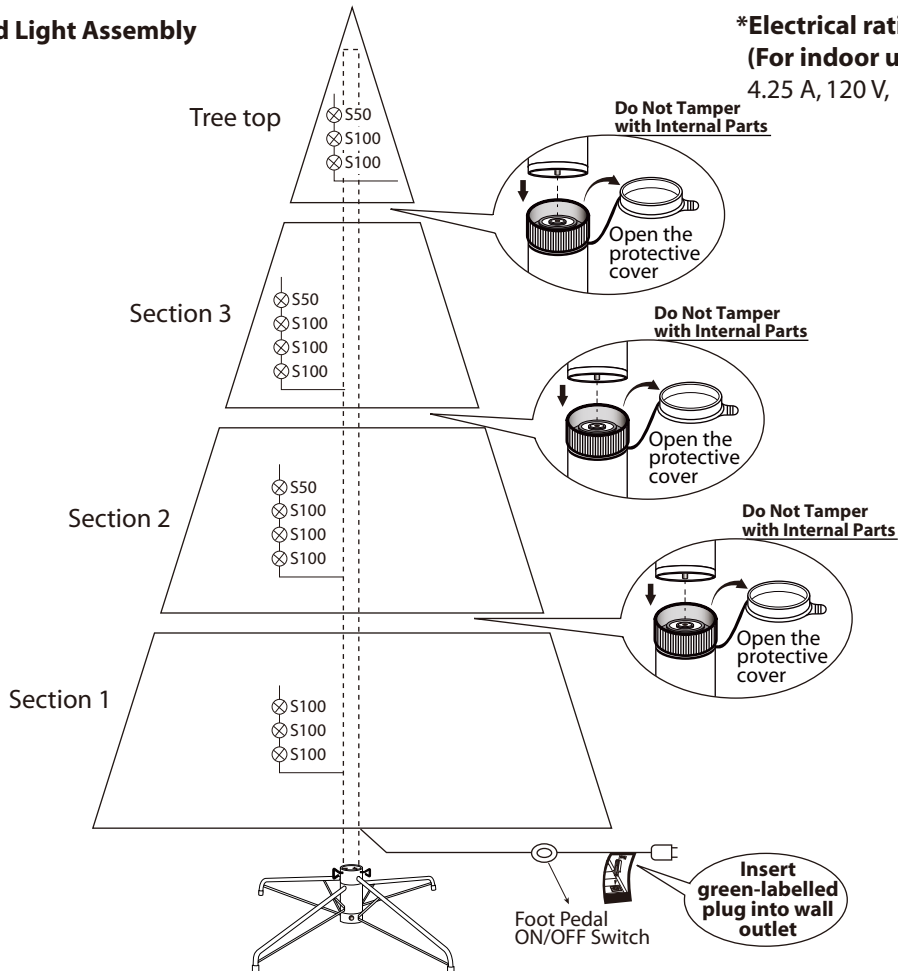

***Electrical rating for the tree**
(For indoor use only.)
4.25 A, 120 V, 60 Hz

3. Each tree section is numbered with a sticker. Please identify all sections before assembling.
4. Assemble the tree from the bottom to the top. Start with the bottom section and remove protective cap before inserting into the assembled stand. Make sure the pole is firmly inserted and secured into the stand.

- Continue by inserting the upper tree section(s) into the lower section(s), finishing with the tree top.
- Allow branches to fall into place or gently pull up and out. When adjusting branches, be sure that all wires are free of branch hinges.
- Insert green-labelled plug into the wall outlet. (See Fig. B.) Your entire tree should now be lit. If some bulbs do not light or flicker, search for any loose plugs and/or broken, loose or missing bulbs. Connect the plugs or replace the bad bulbs promptly in order to maintain the performance and life expectancy of your pre-lit tree.
- Begin to shape the branches and tips working from the bottom to the top. Start with tips farthest from the pole and fan out one to the right, one to the left and one at the centre of the main stem. (See Fig. C.)

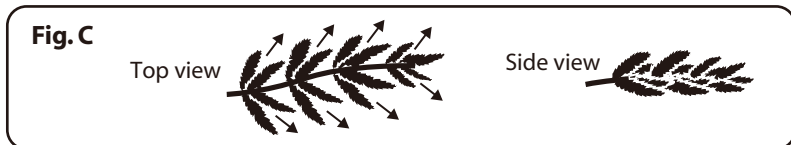

- After shaping the entire tree following the previous step, slightly upsweep all branch tips for a uniform look. Shift branches to fill any gaps. Your Christmas tree is now complete and ready to be decorated.

STORAGE INSTRUCTIONS

- Unplug cord from the wall outlet first and then remove all ornaments and decorations.
- Disassemble the tree from the top to the bottom. Start with the tree top: gently lift straight up to remove from section below and fold all branches toward the pole.
- In case of difficulty separating the tree pole (trunk), apply a small amount of lubricant at the joint and rotate the upper pole in both directions. Lift up the upper pole again.
- Continue by gently lifting straight up each section(s) from the section below, and fold all branches toward the pole until the bottom section is removed from the tree stand. Put the protective cap on the poles to avoid damaging the internal parts. (See Fig. D.)
- Carefully place all tree sections into shipping box and tape it shut.
- When not in use, please store your tree in a cool, dry place away from sunlight. Exposing your tree to excessive heat or humidity may damage your tree.
- This product has a polarized plug (one blade is wider than the other) as a feature to reduce the risk of electric shock. This plug will fit in a polarized outlet only one way. If the plug does not fit fully in the outlet, reverse the plug. If it still does not fit, contact a qualified electrician.
- Do not use with an extension cord unless plug can be fully inserted. Do not alter or replace the plug.

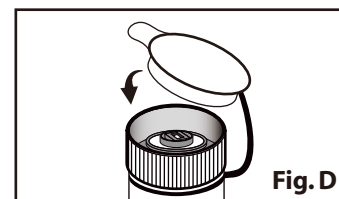

For pre-lit trees, if the tree does not illuminate:

- Please check to make sure that all plugs are properly connected and that the power cord is plugged into the wall outlet. Refer to assembly guide for instructions. (If the tree comes with a foot pedal, try stepping on the ON/OFF button.)
- Please check for loose, broken or missing light bulbs and replace as needed.
- When multiple products are connected together, do not exceed the lowest of the indicated maximum wattage on the cord tag near the connected product's receptacle.

Loose Hinge Pin

- Extra hinge pins are included for repairing the hinges. Place the branch into the slot of the bracket.
- Insert a new hinge pin through the hole and secure using the retainer washer. (See Fig. E.)

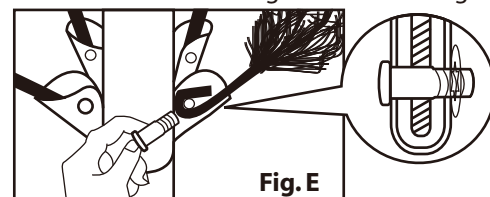

Replace the cord set fuse

- Grasp plug and remove from the receptacle or other outlet device. Do not unplug by pulling on the cord.
- Open fuse cover. Slide fuse access cover on top of attachment plug toward blades.
- Remove fuse carefully.
- Risk of fire. Replace fuse with only a 7 A, 125 V fuse (provided in the plug).
- Close fuse cover. Slide the fuse access cover on top of attachment plug away from blades.

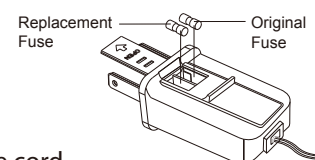

Replace the light string fuse

- Grasp plug and remove from the receptacle or other outlet device. Do not unplug by pulling on the cord.
- Open fuse cover. Slide fuse access cover on top of attachment plug toward blades.
- Remove fuse carefully.
- Risk of fire. Replace fuse with only a 3 A, 125 V fuse (provided in the replacement bag).
- Close fuse cover. Slide the fuse access cover on top of attachment plug away from blades.

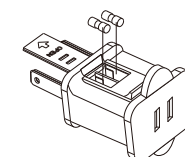

CAUTION: Risk of fire. Do not replace attachment plug.

Do not remove the safety device (fuse). Discard product if the attachment plug is damaged.

SPARE PARTS

Each tree includes hinge pins/washers, and for pre-lit trees, spare bulbs and fuses are also included. If extra parts are needed, please contact our customer service centre.

This product carries a one (1) year warranty against defects in workmanship and materials. Trileaf Distribution agrees to replace a defective product, within the stated warranty period, when returned to the place of purchase with proof of purchase. This product is not guaranteed against wear or breakage due to misuse and/or abuse.

Made in China

Imported by/ Trileaf Distribution Trifeuil Toronto, Canada M4S 2B8

DATE CODE / DATE DE CODE: 22318