

# HOLIDAY LIVING®

Holiday Living & Design® is a registered trademark of LF, LLC. All rights reserved.

ITEM #0712479

## 7.5 FT PRE-LIT YORK CASHMERE PINE TREE

MODEL #TG76M4F74C01

**Français p. 7**



**ATTACH YOUR RECEIPT HERE**

Serial Number \_\_\_\_\_

Purchase Date \_\_\_\_\_



**Questions, problems, missing parts?** Before returning to your retailer, call our customer service department at 1-888-919-0070, 8 a.m. - 5 p.m., EST, Monday - Friday.

AB1641

# PACKAGE CONTENTS

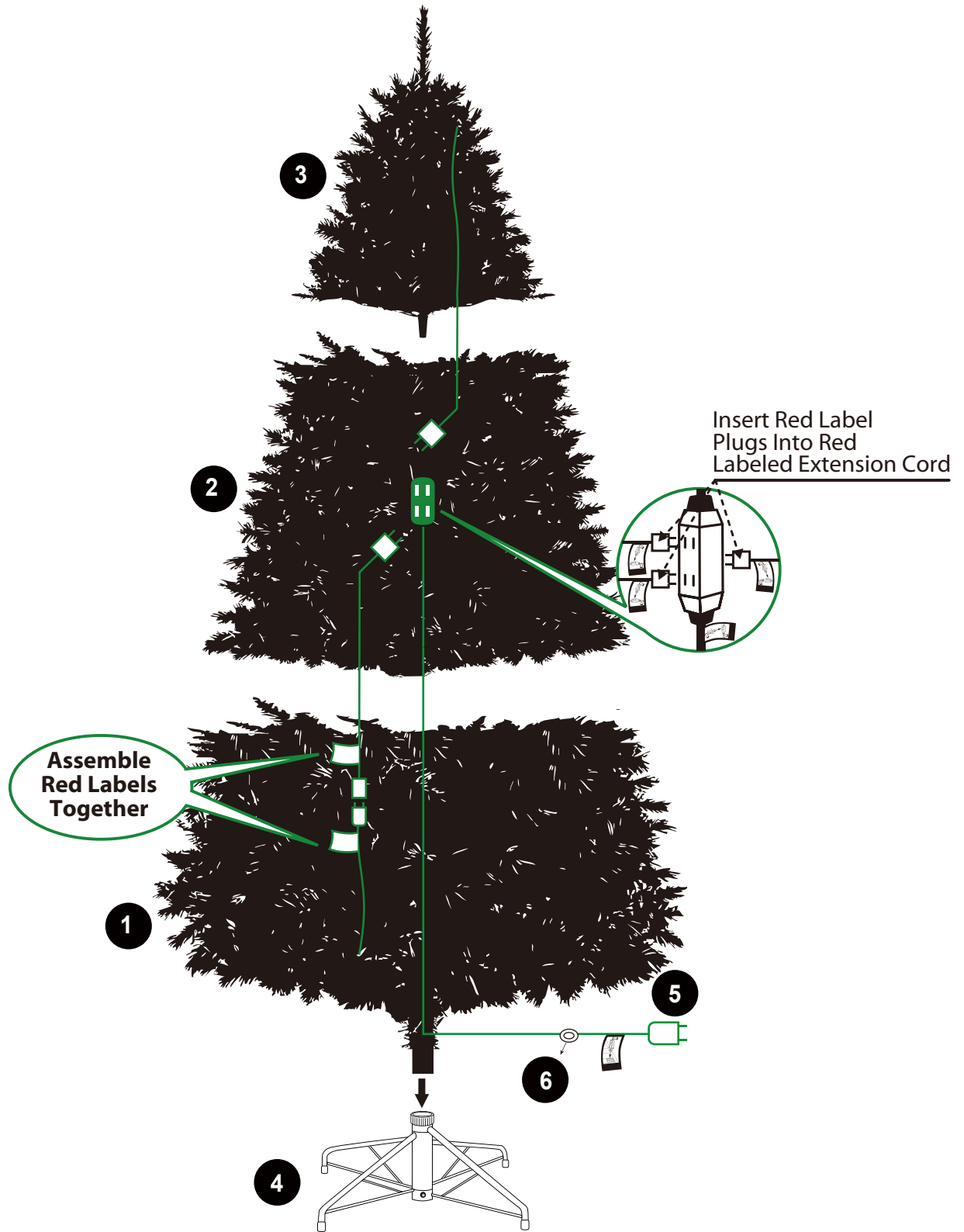

PART	DESCRIPTION	QUANTITY
1	Tree Bottom	1
2	Tree Middle	1
3	Tree Top	1
4	Tree Stand	1
5	Cord (preassembled)	1
6	Foot Pedal (preassembled)	1

## SAFETY INSTRUCTIONS

---

Please read and understand this entire manual before attempting to assemble, operate or install the product.

### RISK OF FIRE

Do not replace attachment plug. It contains a safety device (fuse) that should not be removed. Discard product if the attachment plug is damaged.

### CAUTION

To reduce the risk of overheating, replace burned-out lamps promptly. Use 2.5-volt lamps only.

- Do not use seasonal products outdoors unless marked suitable for indoor and outdoor use. When products are used in outdoor applications, connect the product to a Ground Fault Circuit Interrupting (GFCI) outlet. If one is not provided, contact a qualified electrician for proper installation.
- This seasonal product is not intended for permanent installation or use.
- Do not mount or place near gas or electric heaters, fireplaces, candles or other similar sources of heat.
- Do not secure the wiring of product with staples or nails, or place on sharp hooks or nails.
- Do not let lamps rest on the supply cord or on any wire.
- Unplug the product when leaving the house, when retiring for the night, or if left unattended.
- This is an electric product--not a toy! To avoid risk of fire, burns, personal injury and electric shock, do not play with or place where small children can reach it.
- Do not use this product for other than its intended use.
- Do not hang ornaments or other objects from cord, wire, or light string.
- Do not close doors or windows on the product or extension cords as this may damage the wire insulation.
- Do not cover the product with cloth, paper or any material not part of the product when in use.
- This product is equipped with push-in type lamps. Do not twist lamps.
- This product employs overload protection (fuse). A blown fuse indicates an overload or short-circuit situation. If the fuse blows, unplug the product from the outlet. Also unplug any additional strings or products that may be attached to the product. Replace the fuse as per the user servicing instructions (follow product marking for proper fuse rating) and check the product. If the replacement fuse blows, a short-circuit may be present and the product should be discarded.
- Read and follow all instructions that are on the product or provided with the product.

**SAVE THESE INSTRUCTIONS.**

## PREPARATION

---

Before beginning assembly of product, make sure all parts are present. Compare parts with package contents list. If any part is missing or damaged, do not attempt to assemble the product.

**Estimated Assembly Time: 5 minutes.**

No Tools Required for Assembly.

## ASSEMBLY INSTRUCTIONS

1. Open tree stand (4) by pulling apart the legs of the tree stand (4) until they snap into an X-shape. Place tree stand (4) on a level surface.

**NOTE:** To close tree stand (4), push the button in middle and fold the legs back together.

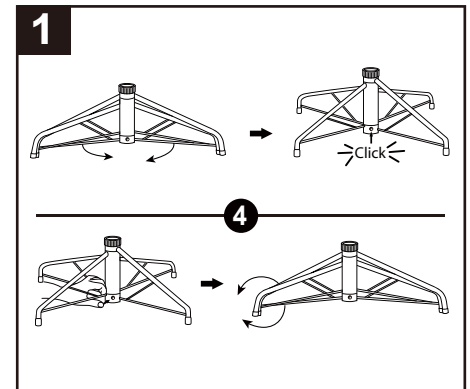

2. Remove protective cap from tree bottom (1). Insert tree bottom (1) into tree stand (4).

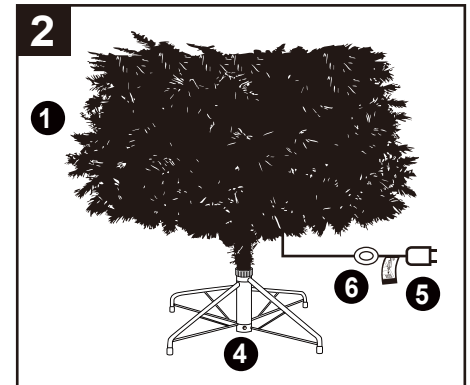

3. Remove protective cap from tree middle (2). Insert tree middle (2) into tree bottom (1).

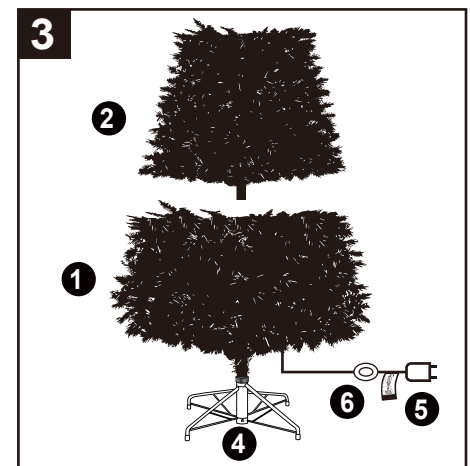

4. Insert tree top (3) into the top hole of the tree middle (2).

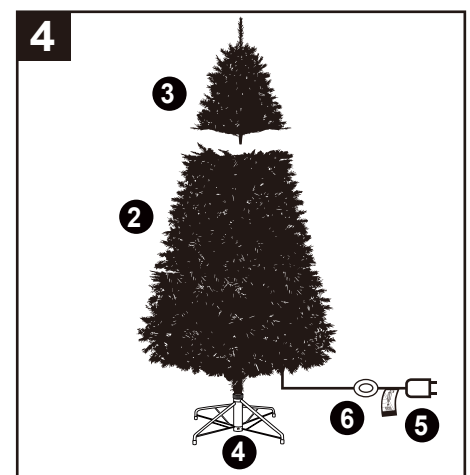

- Shape and shift tree branches to fill in any gaps.  
Insert the red-label plugs into red-label extension cord and insert the plug of the green label extension cord (5) into a wall outlet.

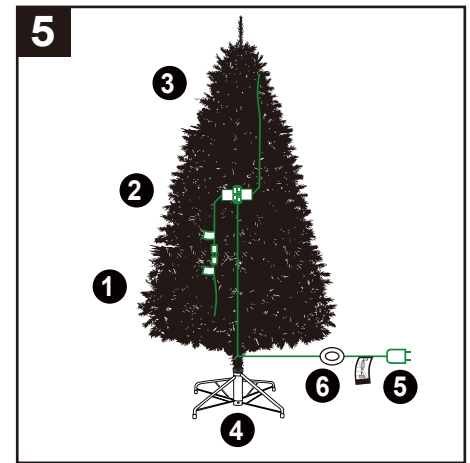

## CARE AND MAINTENANCE

- Before using or reusing, inspect product carefully. Discard any products that have cut, damaged or frayed wire insulation or cords, cracks in the lamp holders or enclosures, loose connections, or exposed copper wire.
- When storing the product, carefully remove the product from wherever it is placed, including trees, branches, or bushes, to avoid any undue strain or stress on the product conductors, connections and wires.
- When not in use, store neatly in a cool, dry location protected from sunlight.

### BULB REPLACEMENT INSTRUCTIONS:

1. Grasp plug and remove from the receptacle or other outlet device.  
Do not unplug by pulling on cord.
2. Lift up to unsnap locking tab; then pull lamp and plastic base straight out of lamp holder.
3. Replace lamp with only 2.5-volt push-in type lamp provided with product.

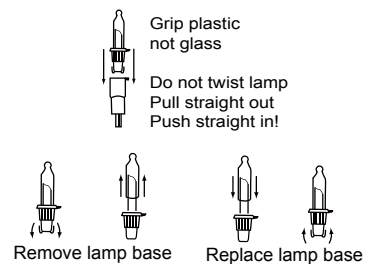

### FUSE REPLACEMENT INSTRUCTIONS:

1. Grasp the power cord plug and remove from the receptacle or other outlet device. Do not unplug by pulling on cord.
2. Open fuse cover by sliding open the fuse access cover on top of attachment plug toward blades.
3. Remove fuse carefully: turn fuse holder over, remove fuse.
4. Risk of fire. Replace fuse only with 3-amp, 125-volt fuse for decorative lighting string(provided with product). If applicable, replace fuse only with 5A-amp, 7A-amp or 10-amp, 125-volt fuse for cord-set (see fuse current on cord-set plug).
5. Close fuse cover by sliding closed the fuse access cover on top of attachment plug.

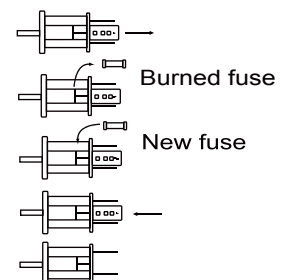

## TROUBLESHOOTING

PROBLEM	POSSIBLE CAUSE	CORRECTIVE ACTION
A section will not light.	1. Bulb is loose. 2. Bulb broke or fell out.	1. Start with the first unlit bulb, then gently push (don't twist) each bulb firmly into the socket. 2. Look and feel for a broken bulb in the socket or an empty socket where a bulb has fallen out.
Bulb is broken.	Bulb broke.	Mark the bulb with a piece of tape and unplug the tree before removing the bulb socket and any fragments. Replace the broken bulb.
One bulb will not light.	Bulb burned out.	Replace any burned out bulbs.

## REPLACEMENT PARTS LIST

For replacement parts, call our customer service department at 1-888-919-0070, 8 a.m. - 5 p.m., EST, Monday - Friday.

PART	DESCRIPTION
A	Fuse
B	Bulb

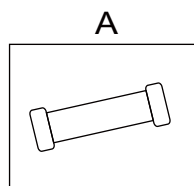

Fuse

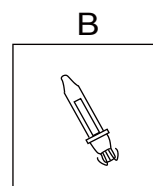

Bulb

**PRINTED IN CHINA**

Holiday Living & Design® is a registered trademark of LF, LLC. All rights reserved.

**HOLIDAY**  
LIVING®  
Lowe.com