

TREE ASSEMBLY INSTRUCTIONS

Congratulations on purchasing your new tree from **Polygroup!** Carefully follow the instructions below on how to quickly and easily set up your new tree.

1. Before you start to assemble your tree, choose an appropriate location near a wall outlet.
2. Assemble the tree stand and place on a level surface. (See Fig. A)

Fig. A - Tree Stand Assembly

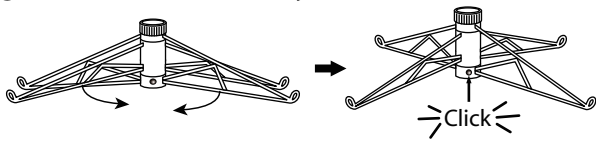

Pull apart the legs of the stand so that they are snapped into an x-shape, place the tree stand on a level surface.

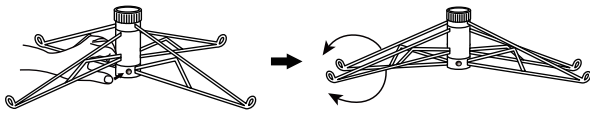

To close the stand, press the metal button and fold the legs together.

Fig. B - Tree and Light Assembly

***Electrical Rating For The Tree
(For Indoor Use Only)**

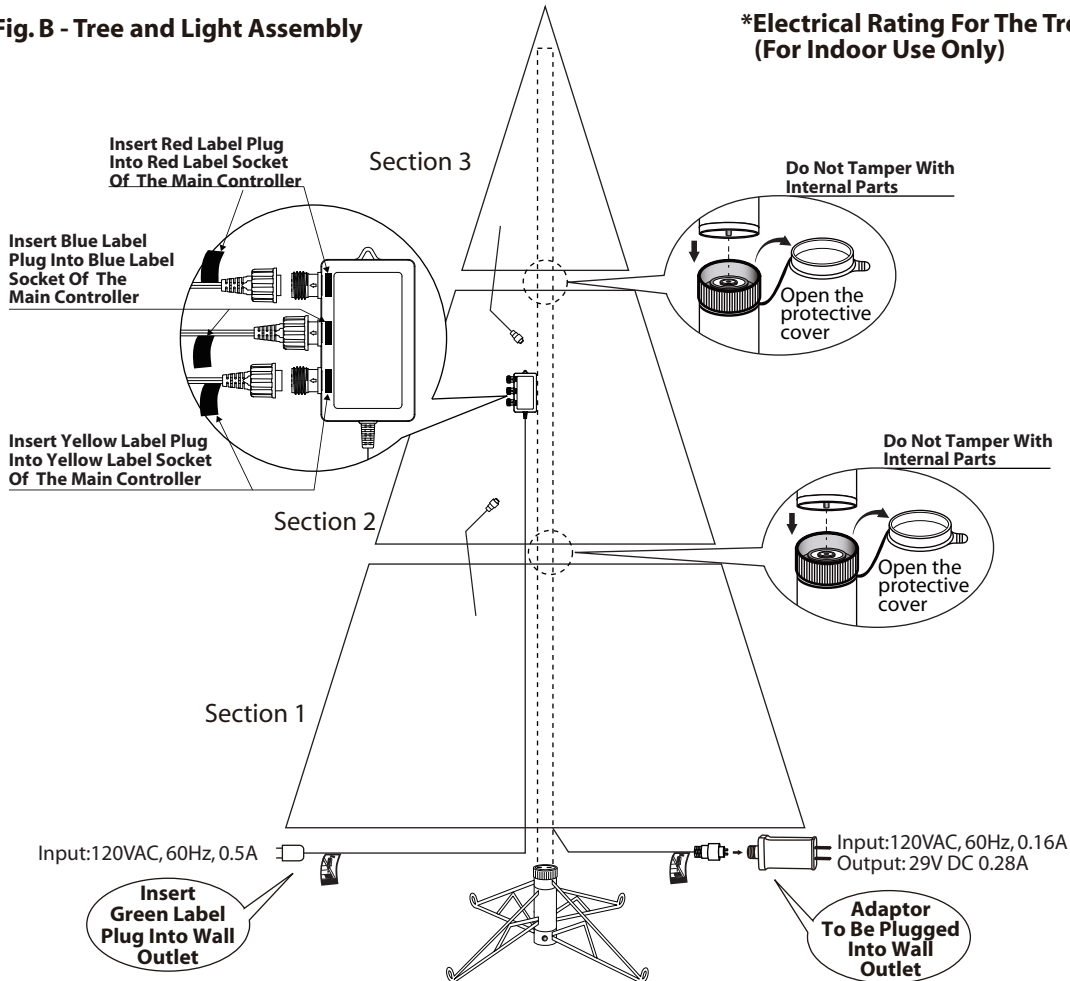

3. Each tree section is numbered with a tag. Please identify all sections before assembling.
4. Assemble the tree from the bottom to the top. Start with the bottom section and remove protective cap before inserting into the assembled stand. Make sure the pole is firmly inserted and secured into the stand.
5. Continue by inserting the upper tree section(s) to the lower section(s) until inserting the tree top.
6. Allow branches to fall into place or gently pull up and out. When adjusting branches, be sure that all wires are free of branch hinges.
7. Just plug the adaptor (connecting with the tree power cord) into the wall outlet (See Fig. B), your entire tree should now be lit. If some bulbs do not light or flickers, search for any loose plugs and/or broken, loose or missing bulbs. Replace bulbs promptly in order to maintain the performance and life expectancy of your pre-lit tree.
8. Connect the red label extension cord of the digital light from the tree top section to the red label socket on the main controller box and then twisting the lock-nut in clockwise by hand tighten.
9. Connect the blue label extension cord of the digital light from the tree middle section to the blue label socket on the main controller box and then twisting the lock-nut in clockwise by hand tighten.
10. Connect the yellow label extension cord of the digital light from the tree lower section to the yellow label socket on the main controller box and then twisting the lock-nut in clockwise by hand tighten.

NOTE: Ensure the three extension cords are connected onto the correct sockets on the main controller before plug the main controller power cord from the wall outlet to power on the digital lights.

MODEL #: TG76P3914L00,DLCW2IRGB601(LI400LC-CC-B2)

11. Connect the main controller power cord to the wall outlet.
12. Begin to shape the branches and tips working from the bottom to the top. Start with tips farthest from the pole and fan out one to the right, one to the left and one at the center of the main stem. (See Fig. C)

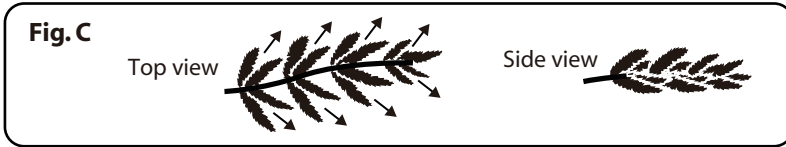

13. This is a Simple Shape tree. Just slightly upsweep all branch tips for a uniform look. Shift branches to fill any gaps. Your Christmas tree is now complete and ready to be decorated.

Operating Instruction For Color Wheel Remote Control for Digital Color Changing Lights

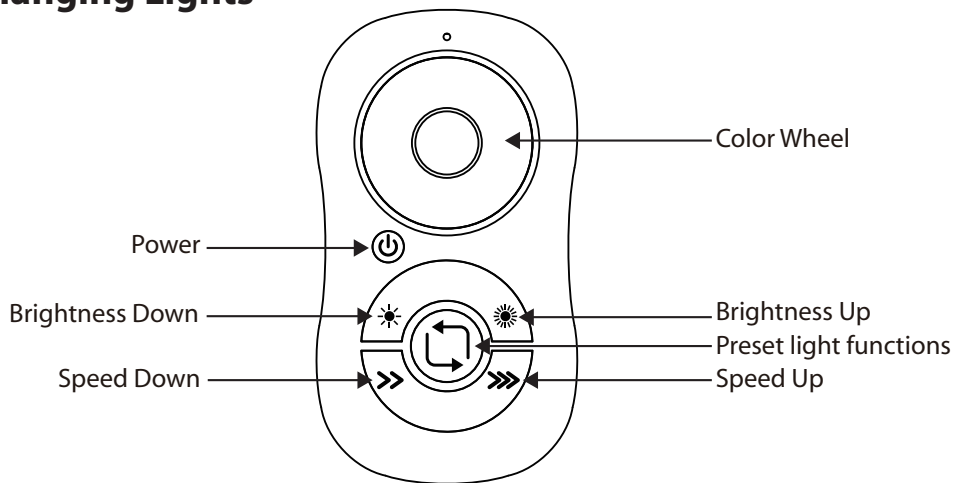

- (1) Remove the insulation tab before using the remote control.
- (2) Press the button to turn the digital lights ON and OFF.
- (3) Touch the color wheel to display all digital lights in one color. Drag your finger around the color wheel to select your desired color.
- (4) Press buttons to select different lighting effects:
 1. Crosswave
 2. Fade the Rainbow
 3. Tri-Color Chase
 4. Multi-color chase
 5. Stack up
 6. Stack down
 7. Steady on multi
- (5) Press and to adjust the speed.
- (6) Press and to adjust the brightness of the lights.

Batteries Replacement For Remote Control

1. Remove the product from the packaging.
2. Open the battery compartments by removing the battery cover.
3. Insert fresh batteries into the compartments and make sure the polarities are correct.
4. Close the battery cover.

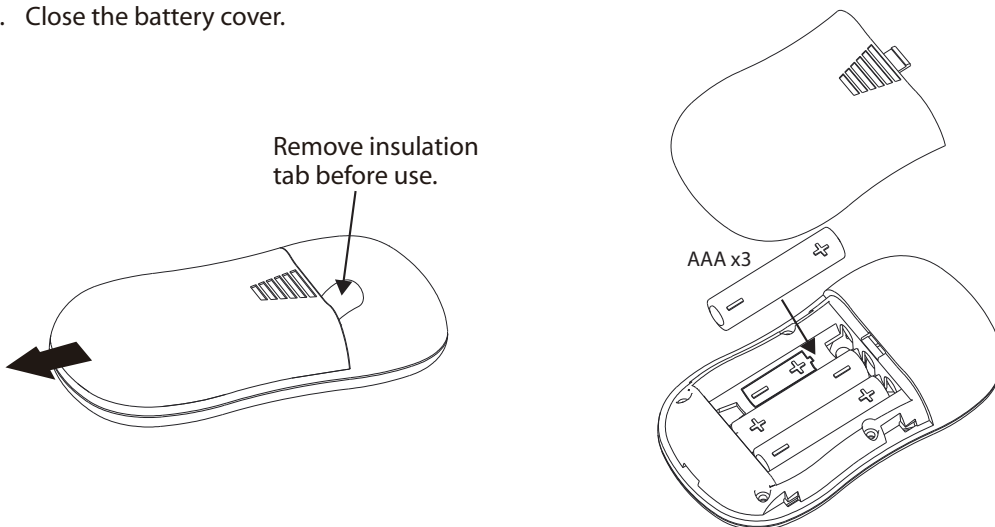

NOTE TO THE REMOTE CONTROLLER:

- (1) Do not mix old and new batteries.
- (2) Do not mix alkaline, carbon-zinc, lithium, or Re-chargeable (Nickel-Cadmium or other types) Batteries.
- (3) Remove batteries when not used for an extended period of time, or when depleted.
- (4) Do not use rechargeable batteries.
- (5) Dispose of batteries properly by following directions on batteries.

STORAGE INSTRUCTIONS

1. Unplug adaptor from the wall outlet first and then remove all ornaments and decorations.
2. Twisting the lock-nuts in anti-clockwise and remove the plugs from the main controller to release the three extension cords of the digital lights.

NOTE: Ensure the main controller power cord is remove from the wall outlet before remove the three extension cords from the main controller of the digital lights.

3. Disassemble the tree from the top to the bottom. Start with the tree top and gently lift straight up to remove from section below and fold all branches toward the pole.
4. Continue by gently lifting straight up each section(s) from the section below and fold all branches toward the pole until the bottom section is removed from the tree stand. Cover the protective cap on the poles to avoid damaging the internal parts. **(See Fig. D)**
5. Carefully place all tree sections into shipping box and tape it shut.
6. When not in use, please store your tree in a cool, dry place away from sunlight. Exposing your tree to excessive heat or humidity may damage your tree.

**TROUBLE SHOOTING TIPS****For Pre-lit Trees, If The Tree Does Not Illuminate**

1. Please check to make sure the power cord is properly connected with the adaptor and the adaptor is firmly plug to the wall outlet.
2. Turning the poles gently to make sure pole to pole are connected into place.
3. Check for loose connection between light string plugs and extension cords.
4. Please check for loose, broken or missing light bulbs and replace as needed.

Loose Hinge Pin

1. Extra hinge pins are included for repairing the hinges. Place the branch into the slot of the bracket.
2. Insert a new hinge pin through the hole and secure using the retainer washer. **(See Fig. E)**

SPARE PARTS

Each tree includes hinge pins/washers, and for pre-lit trees spare bulbs are also included. If extra parts are needed, please contact our customer service center.

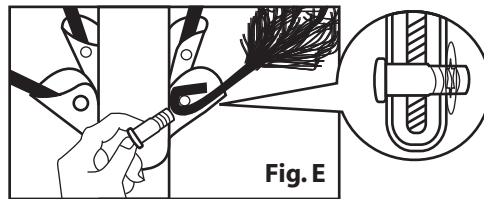
**⚠ WARNING**

1. Use only power adaptor supplied with this product, using a different adaptor will damage the lights and cause fire, electrical shock hazards.
2. FOR INDOOR USE ONLY.

IMPORTANT SAFETY INSTRUCTIONS

When using electrical products, basic precautions should always be followed including the following:

- a) READ AND FOLLOW ALL SAFETY INSTRUCTIONS.
- b) Do not use seasonal products outdoors unless marked suitable for indoor and outdoor use. When products are used in outdoor applications, connect the product to a Ground Fault Circuit Interrupting (GFCI) outlet. If one is not provided, contact a qualified electrician for proper installation.
- c) This seasonal use product is not intended for permanent installation or use.
- d) Do not mount or place near gas or electric heaters, fireplace, candles or other similar sources of heat.
- e) Do not secure the wiring of the product with staples or nails, or place on sharp hooks or nails.
- f) Do not let lamps rest on the supply cord or on any wire.
- g) Unplug the product when leaving the house, when retiring for the night, or if left unattended.
- h) This is an electric product – not a toy! To avoid risk of fire, burns, personal injury and electric shock it should not be played with or placed where small children can reach it."
- i) Do not use this product for other than its intended use.
- j) Do not hang ornaments or other objects from cord, wire, or light string.
- k) Do not close doors or windows on the product or extension cords as this may damage the wire insulation.
- l) Do not cover the product with cloth, paper or any material not part of the product when in use.
- m) This product has a polarized plug (one blade is wider than the other) as a feature to reduce the risk of electric shock. This plug will fit in a polarized outlet only one way. If the plug does not fit fully in the outlet, reverse the plug. If it still does not fit, contact a qualified electrician. Do not use with an extension cord unless plug can be fully inserted. Do not alter or replace the plug.

- n) This product is equipped with push-in type lamps. Do not twist lamps.
- o) This product employs overload protection (fuse). A blown fuse indicates an overload or short-circuit situation. If the fuse blows, unplug the product from the outlet. Also unplug any additional strings or products that may be attached to the product. Replace the fuse as per the user servicing instructions (follow product marking for proper fuse rating) and check the product.
- p) Read and follow all instructions that are on the product or provided with the product.
- q) **SAVE THESE INSTRUCTIONS.**

Use and Care Instructions

- a) Before using or reusing, inspect product carefully. Discard any products that have cut, damaged or frayed wire insulation or cords, cracks in the lampholders or enclosures, loose connections, or exposed copper wire.
- b) When storing the product, carefully remove the product from wherever it is placed, including tree, branches, or bushes, to avoid any undue strain or stress on the product conductors, connections, and wires.
- c) When not in use, store neatly in a cool, dry location protected from sunlight.

User Servicing Instructions

Fuse replacement:

- a) Grasp plug and remove from the receptacle or other outlet device. Do not unplug by pulling on cord.
- b) Open fuse cover. Slide open fuse access cover on top of attachment plug towards blades.
- c) Remove fuse carefully.
- d) Risk of fire. Replace fuse only with 5 Amp, 125 Volt fuse for the power cord set and 3 Amp, 125 Volt fuse for decorative lighting string (provided with product).
- e) Close fuse cover. Slide closed the fuse access cover on top of attachment plug.
- f) Risk of fire. Do not replace attachment plug. Contains a safety device (fuse) that should not be removed. Discard product if the attachment plug is damaged.

Lamp replacement:

- a) Grasp plug and remove from the receptacle or other outlet device. Do not unplug by pulling on cord.
- b) Pull lamp and plastic base straight out of lampholder.
- c) Replace lamp with only 2.5 Volt, 0.43 Watt super brightness type lamp (provided with product). The instruction shall indicate how to exchange the lamp base on the new lamp with the old one if the new lamp base does not fit.

CUSTOMER SERVICE FOR CHRISTMAS TREES

For any questions, assistance, or missing parts, **Do Not Return To Place Of Purchase**. Please contact us at 1-888-919-0070 or visit our website at www.polygroup.com. One of our customer service representatives will be happy to assist you.

Tree ID#: _____	Customer Name: _____
Tree UPC#: _____	Address:(No P.O. Boxes) _____
Store Purchased: _____	City & State: _____
Specify Problem: _____	Zip Code: _____
_____	Day Phone: _____
_____	Date Purchased: _____

TREE ID# IS LOCATED ON END PANEL OF BOX. TREE ID# IS REQUIRED WHEN REQUESTING REPLACEMENT PARTS.